

PRELIMINARY
 Notice: This is not a final specification.
 Some parametric limits are subject to change.

MITSUBISHI GATE COMMUTATED TURN-OFF THYRISTORS

FGC1500A-130DS

HIGH POWER INVERTER USE
 PRESS PACK TYPE

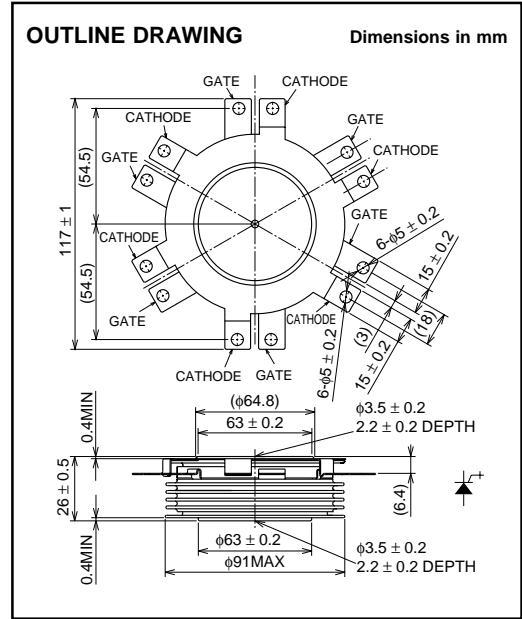
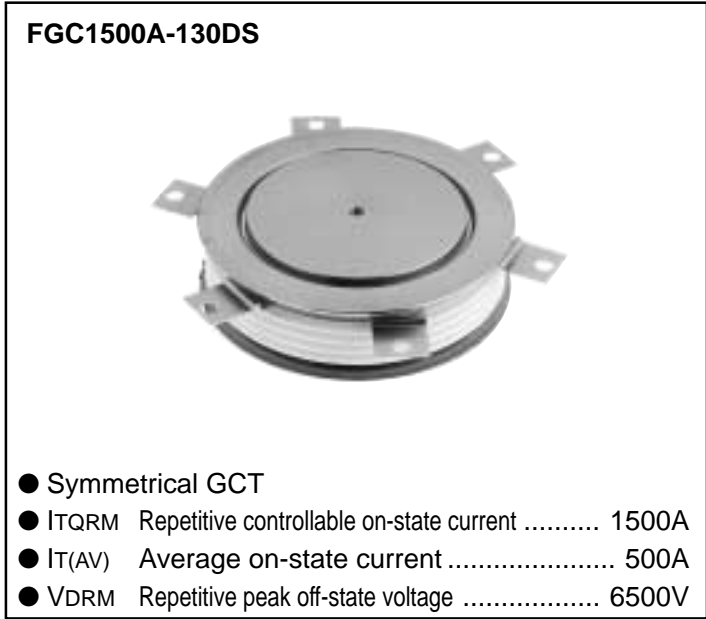

APPLICATION

Inverters, DC choppers, Induction heaters, DC to DC converters.

MAXIMUM RATINGS

Symbol	Parameter	Conditions	Voltage class	Unit
VRRM	Repetitive peak reverse voltage	—	6500	V
VRSM	Non-repetitive peak reverse voltage	—	6500	V
VDRM	Repetitive peak off-state voltage	VGK = -2V	6500	V
VDSM	Non-repetitive peak off-state voltage	VGK = -2V	6500	V
VLTD5	Long term DC stability voltage	VGK = -2V, λ = 100 Fit	3600	V

Symbol	Parameter	Conditions	Ratings	Unit
ITQRM	Repetitive controllable on-state current	VDM = 3/4 VDRM, VD = 3000V, LC = 0.3μH, VRG = 20V Tj = 25/115°C, With GU-D15 (see Fig. 1, 3)	1500	A
IT(RMS)	RMS on-state current	Applied for all conduction angles	780	A
IT(AV)	Average on-state current	f = 60Hz, sinewave θ = 180°, Tr = 55°C	500	A
ITSM	Surge on-state current	One half cycle at 60Hz, Tj = 115°C Start	8	kA
i ² t	Current-squared, time integration		2.7 × 10 ⁵	A ² s
diT/dt	Critical rate of rise of on-state current	VD = 3000V, IT = 1500A, Cs = 0.2μF, Rs = 5Ω Tj = 25/115°C, f = 60Hz, With GU-D15 (see Fig. 1,2)	1000	A/μs
VFGM	Peak forward gate voltage		10	V
VRGM	Peak reverse gate voltage		21	V
IFGM	Peak forward gate current		900	A
IRGM	Peak reverse gate current		1500	A
PFGM	Peak forward gate power dissipation		9	kW
PRGM	Peak reverse gate power dissipation		32	kW
PFG(AV)	Average forward gate power dissipation		180	W
PRG(AV)	Average reverse gate power dissipation		230	W
Tj	Junction temperature		-20 ~ +115	°C
Tstg	Storage temperature		-20 ~ +150	°C
—	Mounting force required	(Recommended value 20kN)	18 ~ 24	kN
—	Weight	Typical value	760	g

PRELIMINARY
 Notice: This is not a final specification.
 Some parametric limits are subject to change.

FGC1500A-130DS

**HIGH POWER INVERTER USE
 PRESS PACK TYPE**

ELECTRICAL CHARACTERISTICS

Symbol	Parameter	Test conditions	Limits			Unit
			Min	Typ	Max	
V _{TM}	On-state voltage	I _T = 1500A, T _j = 115°C	—	—	7.0	V
I _{RRM}	Repetitive peak reverse current	V _{RM} = 6500V, T _j = 115°C	—	—	220	mA
I _{DRM}	Repetitive peak off-state current	V _{DM} = 6500V, V _{GK} = -2V, T _j = 115°C	—	—	150	mA
I _{GRM}	Reverse gate current	V _{RG} = 21V, T _j = 115°C	—	—	100	mA
dv/dt	Critical rate of rise of off-state voltage	V _D = 3000V, V _{GK} = -2V, T _j = 115°C (Expo. wave) (see Fig. 4)	3000	—	—	V/μs
t _{gt}	Turn-on time	I _T = 1500A, V _D = 3000V, di/dt = 1000A/μs, T _j = 115°C	—	—	5.0	μs
t _d	Delay time	C _s = 0.2μF, R _s = 5Ω	—	—	1.0	μs
E _{on}	Turn-on switching energy	With GU-D15 (see Fig. 1, 2)	—	—	2.15	J/P
t _s	Storage time	I _T = 1500A, V _{DM} = 3/4 V _{DRM} , V _D = 3000V C _s = 0.2μF, R _s = 5Ω, V _{RG} = 20V, T _j = 115°C	—	—	3.0	μs
E _{off}	Turn-off switching energy	With GU-D15 (see Fig. 1, 5)	—	—	12	J/P
Q _{RR}	Reverse recovery charge	V _R = 3000V, I _T = 1500A, di/dt = 1000A/μs	—	—	2800	μC
E _{rec}	Reverse recovery energy	C _s = 0.2μF, R _s = 5Ω, T _j = 115°C (see Fig. 5, 6)	—	—	7	J/P
I _{GT}	Gate trigger current	DC METHOD : V _D = 24V, R _L = 0.1Ω, T _j = 25°C	—	—	0.75	A
V _{GT}	Gate trigger voltage		—	—	1.5	V
R _{th(j-f)}	Thermal resistance	Junction to fin	—	—	0.016	°C/W

FGC1500A-130DS

HIGH POWER INVERTER USE
PRESS PACK TYPE

Fig. 1 Turn-on and Turn-off waveform

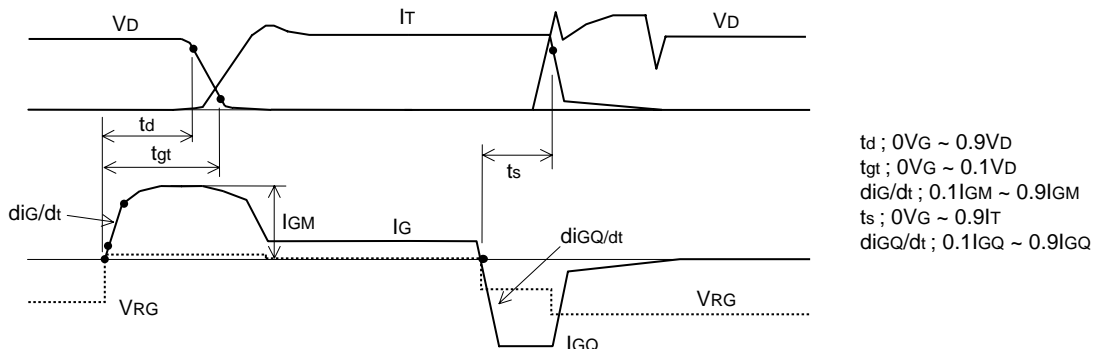

Fig. 2 Turn-on test circuit

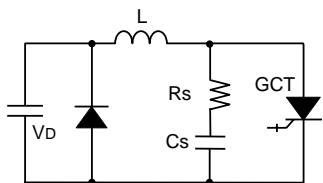

Fig. 3 Turn-off test circuit (With clamp circuit)

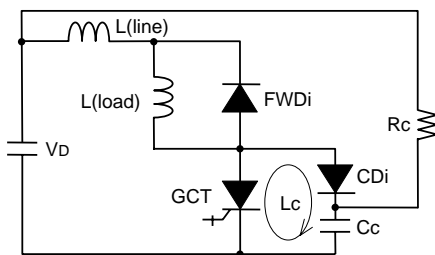

Fig. 4 dv/dt test waveform

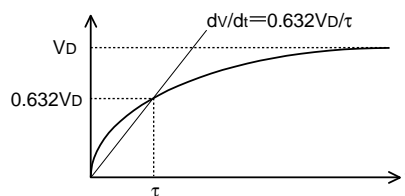
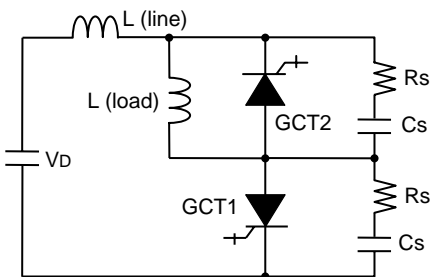
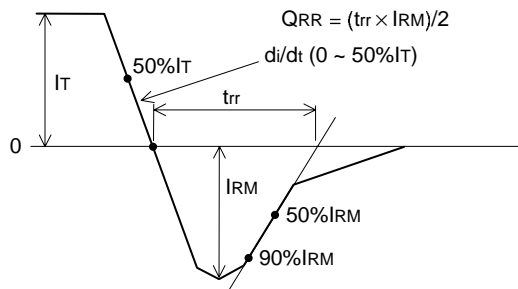

Fig. 5 Turn-off and Recovery test circuit



GCT1 : For turn-off test
GCT2 : For Recovery test

Fig. 6 Reverse recovery waveform



FGC1500A-130DS

HIGH POWER INVERTER USE
PRESS PACK TYPE

PERFORMANCE CURVES

MAXIMUM ON-STATE CHARACTERISTIC

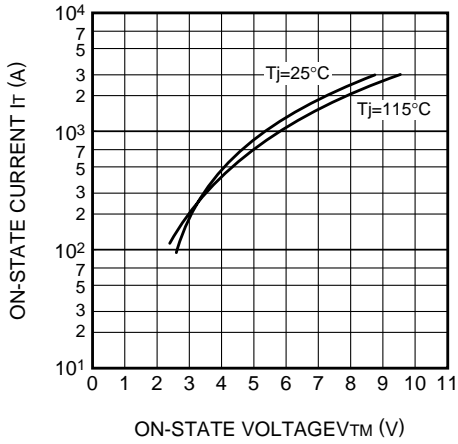

E_{on} VS I_T
(TYPICAL)

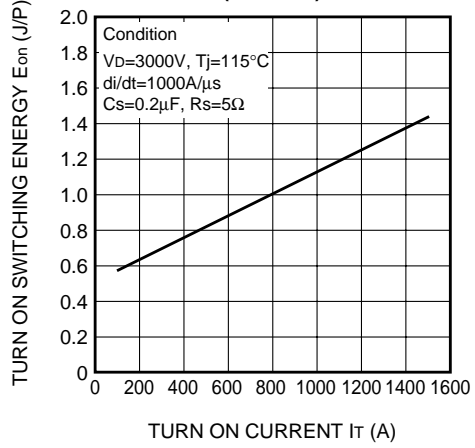

E_{off} VS I_T
(TYPICAL)

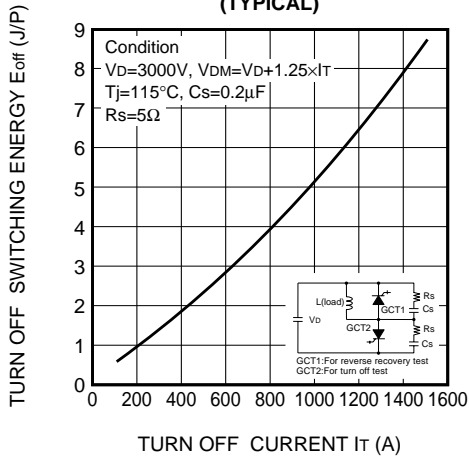

E_{rec} VS I_T
(TYPICAL)

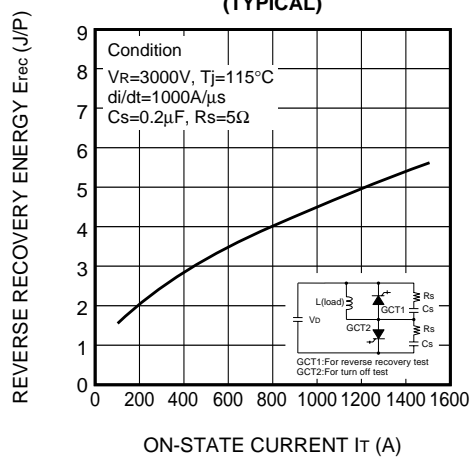

MAXIMUM THERMAL IMPEDANCE
CHARACTERISTIC
(JUNCTION TO FIN)

